

安全指示

1. 在安装或使用本产品时，使用者必须彻底并仔细阅读本操作手册。
2. 所有标上  符号之指示，必须特别注意或执行，否则可能会导致身体伤害。
3. 本产品须由受过正确训练的人员来安装或操作。
4. 为安全起见，禁止以延长线作电源座供应二项以上的电器产品使用。
5. 当连接电源线到电源座时，必须确定此电压低于 AC 250V，且符合标在马达铭牌上的指定电压。
※注意：电控箱电源规格如为 AC220V 时，请勿插接至 AC380V 的电源插座上，否则将出现异常且电机将无法动作。此时请立即关闭电源开关，重新检查电源。持续供应 380V 超过五分钟以上，将可能烧损电控箱上的保险丝 F2、电解电容 (C58、C59) 及电源模块 U14，而危及人身安全。
6. 请不要在日光直接照射的场所、室外及室温 45℃ 以上或 5℃ 以下的场所操作。
7. 请不要在暖气（电热器）旁、有露水的场所及在相对湿度 30% 以下或 95% 以上的场所操作。
8. 请不要在灰尘多的场所、具有腐蚀性物质的场所及有挥发性气体的场所操作。
9. 请注意电源线不要受压或过度扭曲。
10. 电源线的接地线须以适当大小的导线和接头连接到生产工厂的系统地线，此连接必须被永久固定。
11. 所有可转动的部分，必须以所提供的零件加以防范露出。
12. 在第一次通电后，先以低速操作缝纫机并检查转动方向是否正确。
13. 在操作以下动作前，请先关闭电源：
 - 1) 在控制箱与马达上插或拔任何连接插头时。
 - 2) 穿针线时。
 - 3) 翻抬车头时。
 - 4) 修理或作任何机械上的调整时。
 - 5) 机器休息不用时。
14. 修理或高层次的保养工作，仅能由受过适当训练的机电技师来执行。
15. 所有维修用的零件，须由本公司提供认可，方可使用。
16. 请不要以不适当物体来敲击或撞击本产品及各装置。

保修期限

本产品保修期限为购买日期起一年内或出厂月份起两年内。

保修内容

本产品在正常情况且无人失误的操作下，于保修期间无偿的为客户维修使能正常操作。

但以下情况于保修期间将收取维修费用：

- 1、不当使用包括误接高压电源、将产品移做其它用途、自行拆卸、维修、更改、或不依规格范围使用、进水进油及插入异物于本产品。
- 2、火灾、地震、闪电、风灾、水灾、盐蚀、潮湿、异常电压及其它天灾或不当场所造成的损害。
- 3、客户购买后摔落本产品，或客户自行运输（或托付运输公司）造成的损害。

* 本产品在生产及测试上皆尽最大努力和严格控制使其达到高品质及高稳定的标准，但外部的电磁或静电干扰或不稳定的供应电源，仍可能对本产品造成影响或损害，因此操作场所的接地系统一定要确实做好，并建议用户安装故障安全防护装置（如漏电保护器）

1 安装

1.1 电源线的接法

! 如使用于电源供应不稳定之国家或地区时，建议在电源供应端装置电源稳定器之设备、请务必接上大地。

1.2 马达的安装

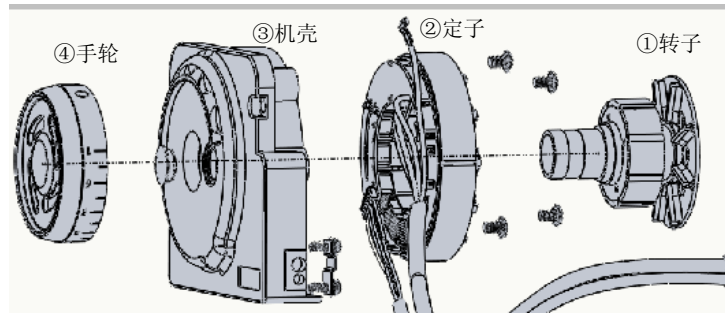

1.3 控速器踏板拉力的调整

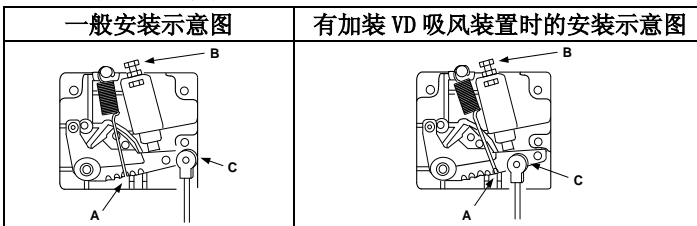

A: 前踏拉力弹簧

B: 后踏紧度制退的调整螺丝组

C: 踏板旋臂拨杆挂钩孔

∴ 踏板连接器有加装 VD 吸风系列装置时，建议将 A 与 C 改变安装如右图所示

1.4 数码显示字体与实际字体对照表

数字字体部分:

实际数值	0	1	2	3	4	5	6	7	8	9
液晶显示	0	1	2	3	4	5	6	7	8	9

英文字体部分

英文字母	A	B	C	D	E	F	G	H	I	J
液晶显示	A	b	C	d	E	F	G	H	I	J
英文字母	K	L	M	N	O	P	Q	R	S	T
液晶显示	k	L	n	n	o	P	q	r	s	t
英文字母	U	V	W	X	Y	Z				
液晶显示	U	v	8	11	Y	≡				

1.5 上下停车、慢速启缝调试



在正常工作界面中、当按 **■** 键显示屏上该指示灯被点亮说明停车在上定位，该指示灯被关闭说明该此时停车位为下停针

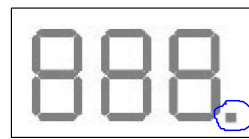

在正常工作界面中、当按 **■** 键显示屏上该指示灯被点亮说明此时慢速起缝打开，该指示灯被关闭说明该此时慢速起缝打关闭。

2: 按键说明

进入和存储内容值	S	进入参数内容值，其内容值如经调整变更后，需按下“S”键予以储存确认
进入参数区功能键	P	一般模式下按下[P]进入用户参数模式(参数内容见 4.1 参数内容表) 按住[P]开机进入技术员参数模式(参数内容见 4.2 参数内容表)
上调节键	▲	1、参数选择区内参数项递增键 2、参数内容区内设定数值递增键 3、停针位选择快捷键
下调节键	▼	1、参数选择区内参数项递减键 2、参数内容区内设定数值递减键 3、慢速起缝选择快捷键

3 操作说明

3.1: 恢复出厂设置

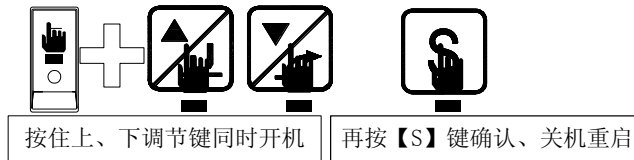

3.2 进入用户模式及修改保存



3.3.: 进入技术员模式及修改保存



4 : 用户参数&技术员参数

4.1 用户参数

参数项	中文说明	范围	初始值	设定键	内容值名称说明与备注
P01	最高转速	020-500	450		车缝时的最高转速设定 (显示的数*10=实际速度)
P02	停针位选择	000-002	000		停针位设定 (0: 上停针; 1: 下停针; 2: 无定位)
P03	慢速起缝开关	000-001	000		慢速起缝开关设定 (0: 关 1: 开)
P04	慢速起缝速度	020-150	040		慢速起缝时的速度设定 (显示的数*10=实际速度)
P05	慢速起缝针数	001-015	002		慢速起缝时的针数设定, 每一单位代表半针
P06	最低转速	200-500	200		车缝时的最低转速设定 (显示的数*10=实际速度)

4.2 技术员参数内容表

参数项	中文说明	范围	初始值	设定键	内容值名称说明与备注
P08	下定位调整	006-018	012		
P21	马达运转方向	000-001	000		马达运转方向设定 (0: 顺时针 1: 逆时针)
P22	自动跑合速度	020-500	350		跑合速度的设置 (显示的数*10=实际速度)
P23	自动跑合跑时间	010-250	020		测试中, 设置跑时间
P24	自动跑合停时间	010-250	020		测试中, 设置停时间
P25	A 项测试	000-001	000		A 项测试设定 (速度持续运行)
P26	B 项测试	000-001	000		B 项测试设定 (执行定位循环运行)
P36	机型	000-002	001		

5: 错误代码表:

错误码	内容	对策
E1	电力模块错误代 不正常过电流或过电压发生 刹车用铝壳电阻或 F1 保险丝异常发生	模块驱动出力与机头出力将全部关闭 等待电源重新开启/复位 (请仔细检查电源板各项机能)
E7	a) 马达插头配线接触不良导致不转。 a) 定位器信号异常。 b) 车头机构死锁或马达皮带异物卷入卡死。 c) 加工物过厚, 马达扭力不足无法贯穿。 d) 模块驱动出力异常。	模块驱动出力与车头出力将全部关闭。 等待电源重新开启/复位。 (请检查车头是否卡住或定位器、马达、模块驱动等信号是否异常)
E11	电源开启即自动找上定位, 但定位器有插入控制箱, 针上信号无法输出。	自动进入无定位器模式, 且切线、扫线、上定位等以及所有定针缝样式缝制功能亦无效。 马达不可正常操作 (请检查定位器是否异常)。



E12	电源开启时，忘记插入定位器。	自动进入无定位器模式运作，且切线、扫线、上定位等以及所有定针缝式样缝制功能亦无效。马达可正常操作。（请检查定位器是否忘记插入或异常）
E14	编码器信号异常	检测编码器信号是否正常，或更换编码器
E15	电力模块不正常过流保护	模块驱动出力与机头出力将全部关闭。等待电源重新开启/复位。（请仔细检查电源板各项机能）

6: 端口示意图

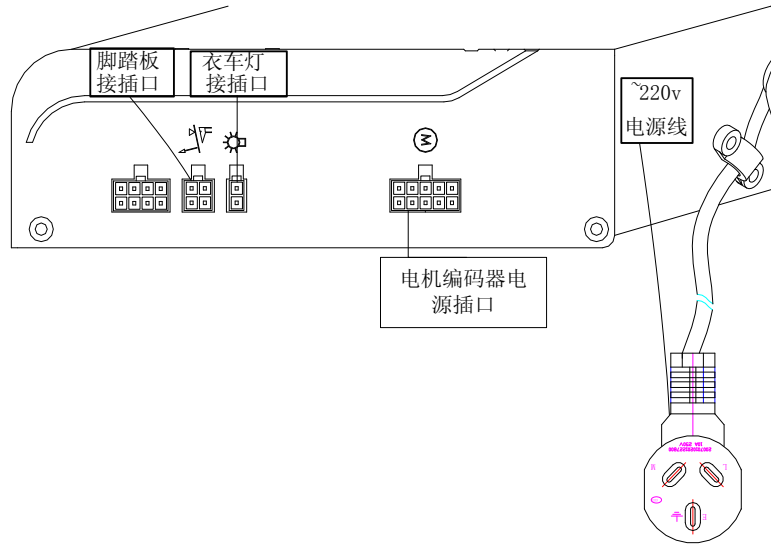
6.1.1: 各个端口说明:



Safety Instruction

1. Users are required to read the operation manual completely and carefully before installation or operation.
2. All the instruction marked with sign  must be observed or executed; otherwise, bodily injuries might occur.
3. The product should be installed and pre-operated by well trained persons.
4. For perfect operation and safety, it is prohibited that using extension cable with multi-outlet for power connection.
5. When connecting power supply cords to power sources, it is necessary to make sure that the power voltage is lower than 250 VAC and matches the rated voltage indicated on the motor's name plate.
-  ※Attention: If the Control Box is AC 220V system, please don't connect the Control Box to AC 380V power outlet. Otherwise, the error will occur and motor will not work. If that happens, please turn off the power immediately and check the power voltage.
6. Don't operate in direct sun light, outdoors area and where the room temperature is over 45 °C or below 5 °C.
7. Please avoid operating near the heater at dew area or at the humidity below 30% or above 95%.
8. Don't operate in area with heavy dust, corrosive substance or volatile gas.
9. Avoid power cord being applied by heavy objects or excessive force, or over bend.
10. The earth wire of power cord must be connected to the system ground of the production plant by proper size of conductions and terminals. This connection should be fixed permanently.
11. All the moving portions must be prevented to be exposed by the parts provided.
12. Turing on the machine in the first time, operate the sewing machine at low speed and check the correct rotation direction.
13. Turn off the power before the following operation:
 - a) Connecting or disconnecting any connectors on the control box or motor.
 - b) Threading needle.
 - c) Raising the machine head.
 - d) Repairing or doing any mechanical adjustment.
 - e) Machines idling.
14. Repairs and high level maintenance work should only be carried out by electronic technicians with appropriate training.
15. All the spare parts for repair must be provided or approved by the manufacturer.
16. Don't use any objects or force to hit or ram the product.

Guarantee Time

Warranty period of this product is 1 year dated from purchasing, or within 2 years from ex-factory date.

Warranty Detail:

Any trouble found within warranty period under normal operation, it will be repaired free of charge. However, maintenance cost will be charged in the following cases even if within warranty period:

1. Inappropriate use, including: wrong connecting high voltage, wrong application, disassemble, repair, modification by incompetent personnel, or operation without the precaution, or operation out of its specification range, or inserting other objects or liquids into the product.
2. Damage by fire, Earth quake, lighting, wind, flood, salt corrosive, moisture, abnormal power voltage and any other damage cause by the natural disaster or by the inappropriate environments.
3. Dropping after purchasing or damage in transportation by customer himself or by customer's shipping agency

Note: We make our best effort to test and manufacture the product for assuring the quality. However, it is possible that this product can be damaged due to external magnetic interference and electronic static or noise or unstable power source more than expected; therefore the grounding system of operate area must guarantee the good earth and it's also commended to install a failsafe device. (Such as residual current breaker)

1 Installation

1.1 Power Connection

⚠ For countries or regions with unstable power supply, it is proposed to install a power stabilizer. 请务必接上大地

1.2 Motor Installation:

Installation of Internal Motor

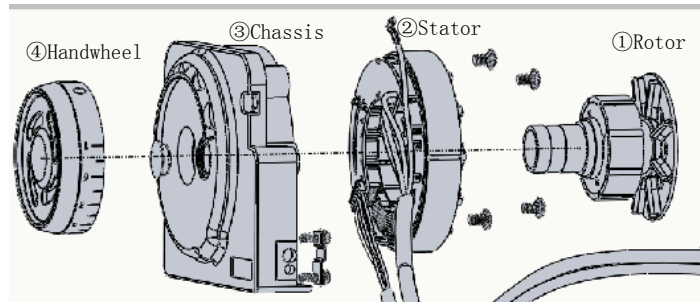

1.3 Adjust The Force Required To Operate The Foot Pedal

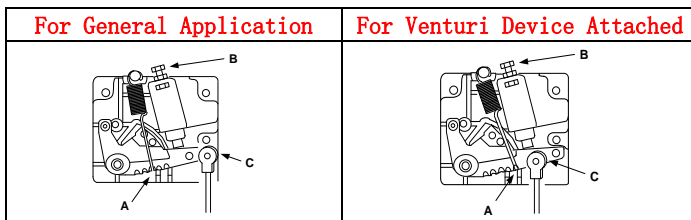

Spring A: Downward force adjustment

Bolt B: Heeling back force adjustment

Hole C: Pedal stroke adjustment

∴ In case of connecting with an air switch on the pedal rod to activate a Venturi Device, please shift the position for A and C as shown below.

1.4 Comparison Table of LCD Display Fonts and Actual Fonts

Arabic Numerals:

Actual	0	1	2	3	4	5	6	7	8	9
Display	0	1	2	3	4	5	6	7	8	9

English Alphabet

Actual	A	B	C	D	E	F	G	H	I	J
Display	A	b	C	d	E	F	G	H	i	J
Actual	K	L	M	N	O	P	Q	R	S	T
Display	k	L	n	n	o	P	q	r	S	T
Actual	U	V	W	X	Y	Z				
Display	U	v	W	X	Y	Z				

1.5 Upper and lower stop debugging, Slow start joint debugging

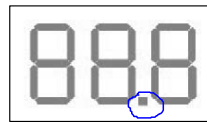

In normal operating interface, when the button on the screen the indicating lamp was lit in the parking position, the indicator light is off the time parking for lower needle stop

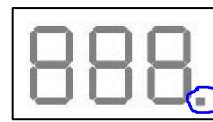

In normal operating interface, when the button on the screen the indication lamp is lit up the slow play slot open, the indicating lamp is off the slow play off the seam.

2: Keysfunction

Entering and saving the parameter value		Enter into the parameter value and save the changed parameter values.
Entering the parameter mode		Press the P key in the Normal Mode can enter into the Users Parameter Mode(parameter value in Parameter Table 4.1) Press the P key and turn on the power can enter into the Technician Parameter Mode(parameter value in Parameter Table 4.2)
On the adjustment key		1. Choose the region parameter items incrementing key 2. Parameter setting value incrementing key 3. Select the shortcut needle position
Under the adjustment key		1. Choose the region parameter items of diminishing key 2. Is decremented key parameter settings 3. Slow play seam selection shortcuts

3 Operating instructions

3.1: Reset the system

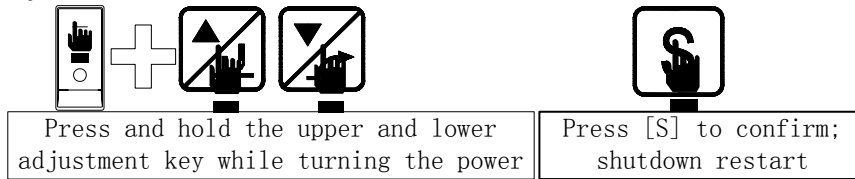

3.2 Enter the user argument and save changes

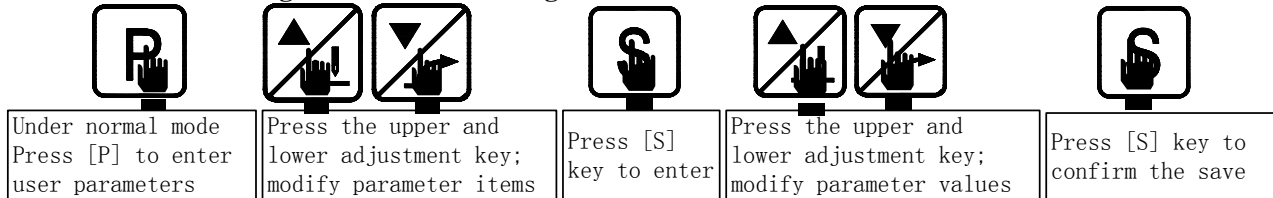

3.3 Enter technician mode and save changes

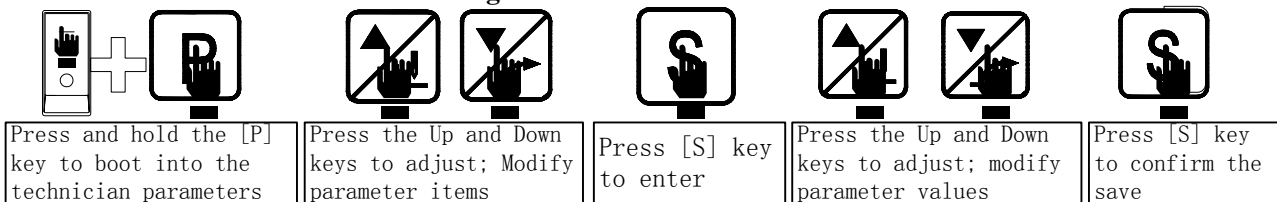

4: User Parameter & Technician Parameter

4.1 User Parameter

Parameters	Parameter Function	Range	Default	Key	Description
P01	Maximum speed	010-500	450		set the max sewing speed (show the actual number *10= speed)
P02	needle stop position selection	000-001	000		Set the needle stop position(0: needle up 1:needle down)
P03	soft start switch	000-001	000		soft start switch setting(0:OFF 1: ON)
P04	soft start sewing speed	010-150	040		soft start sewing speed setting(show the actual number *10= speed)
P05	stitches number of soft start	001-099	004		set the stitches number of soft start, each unit is half stitch
P06	Minimum speed	020-600	500		set the minimum speed (show the actual number *10= speed)

4.2 Technician Parameter

Parameters	Parameter Function	Range	Default	Key	Description
P08	Synchronizer type selection	006-018	012		
P21	motor rotate direction	000-001	000		motor rotate direction setting (0:clockwise 1:counter-clockwise)
P22	auto running speed	020-500	350		auto running speed setting(show the actual number *10= speed)
P23	auto running time	010-250	020		set the auto running time in testing
P24	auto running stop time	010-250	020		set the auto running stop time in testing
P25	Item A test	000-001	000		Item A test setting(continue running with constant speed)
P26	Item B test	000-001	000		Item B test setting(carry out the set loop running)
P36	Type	000-002	001		

5 Error Code Table:

Error	Problem	Measurement
E1	Power Module is faulty. Abnormal over current or voltage. Resistor is damaged or F1 fuse is blown.	System will be shut down until the power resets on. Please check the power board in detail.
E7	a) Bad connection at the motor connector. a) Synchronizer signal error. b) Machine locked or object stuck in the motor pulley. c) Sewing material is too thick.	Module driver output and sewing machine head output should be shut down until the power reset on. (Please check the sewing machine is jammed or synchronizer, motor, module driver single is abnormal.)

	d) Module output is abnormal.	
E11	Auto needle position up when the power on. The synchronizer has connected to the control box, but the needle signal can't be sent out.	Motor still can run, but it automatically starts the no synchronizer mode. All constant-stitch sewing pattern and trimmer /wiper function is invalid. Please check the synchronizer.
E12	Power is turned on without the synchronizer signal.	Motor still can run, but it automatically starts the clutch mode. All constant-stitch sewing pattern and trimmer /wiper function is invalid. Please check the synchronizer.
E14	Encoder signal error	Please check the encoder signal or change the encoder.
E15	Abnormal over current protection for Power Module	Module driver output and sewing machine head output should be shut down until the power reset on. Please check the power board in detail.

6: Schematic diagram of port

6.1.1: Each port name:

